



ภาคผนวก ก.

มหาวิทยาลัยนเรศวร



ภาคผนวก ก
แบบ (Drawing)

มหาวิทยาลัยราชภัฏสุรินทร์

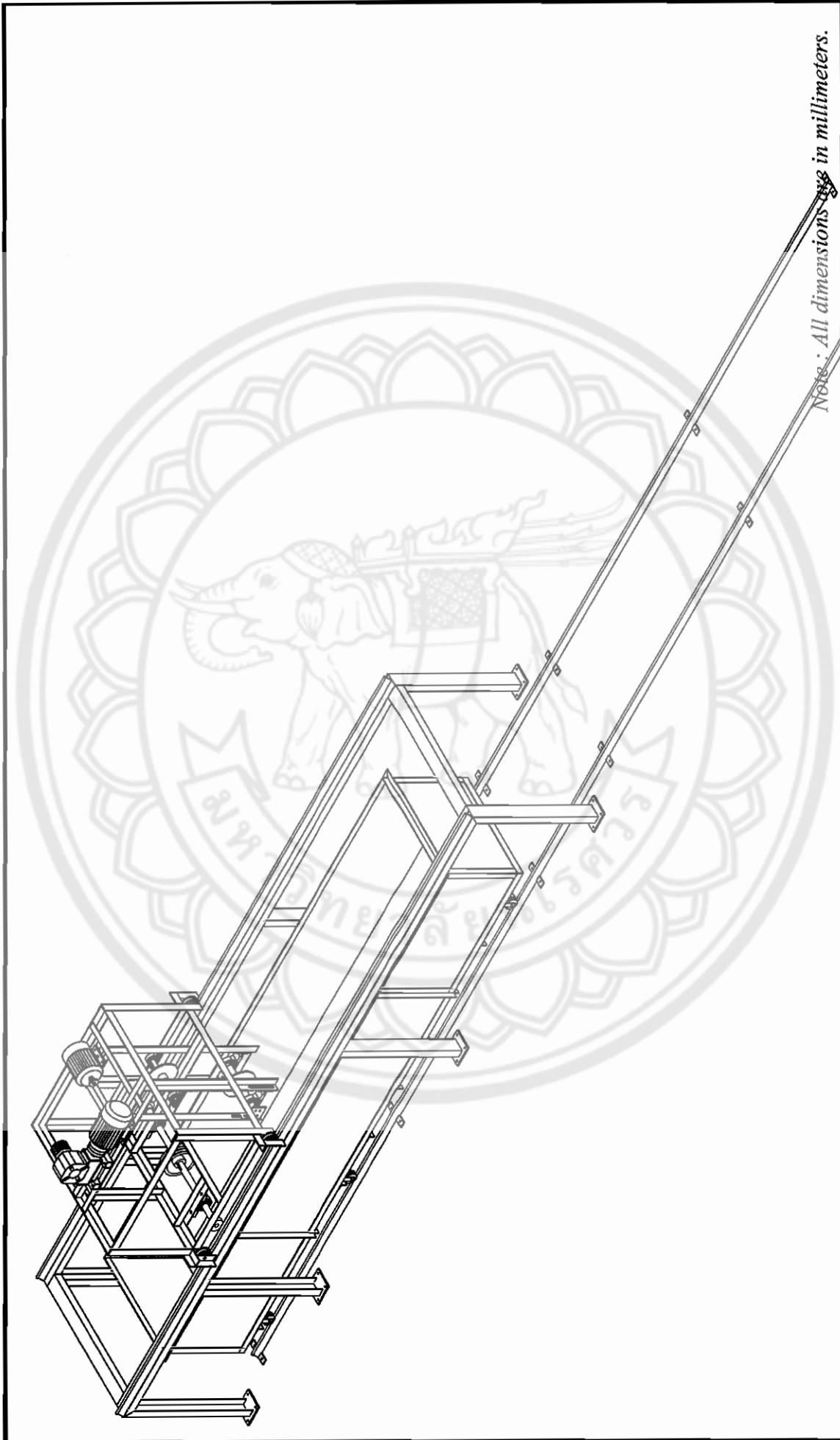

Note: All dimensions are in millimeters.

PROJECT PLATE 01/32	SCALE 1:40	๑๑
DATE 09/10/06	DN BY : NOPPORN SINYONG PANU THONGBOO PARUPAN BOONTON	
ชุดทดสอบใบมีดจอบหมุน		FACULTY OF ENGINEERING NARESUAN UNIVERSITY

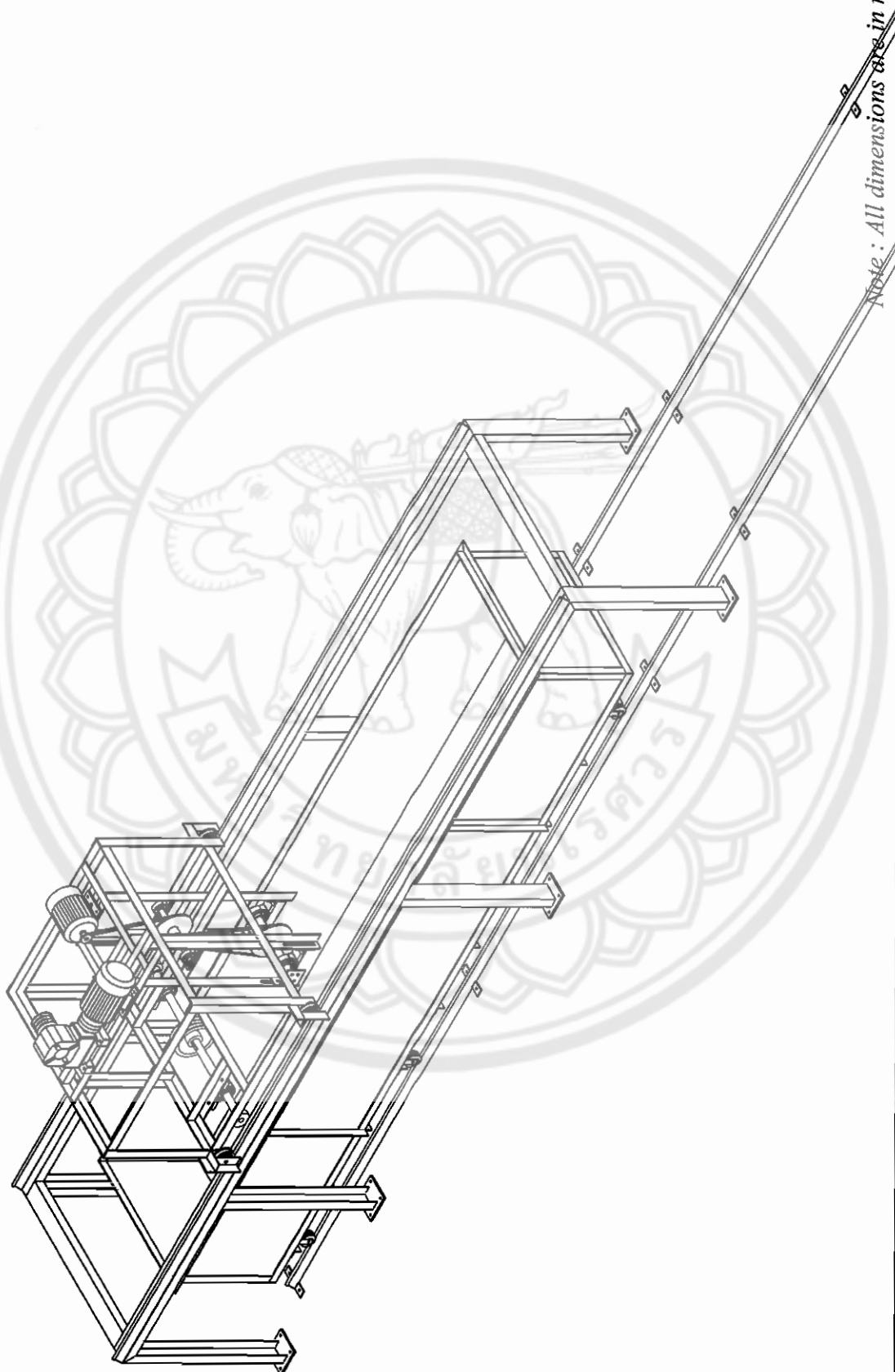

Note : All dimensions are in millimeters.

PROJECT	PLATE 02/32	SCALE 1:35
DATE 09/10/06	DN BY : NOPPORN SINTONG PANU THONGBOO PANUPAN BOONTON	
ชุดทดสอบใบมีดจอบหมุน		
FACULTY OF ENGINEERING NARESUAN UNIVERSITY		

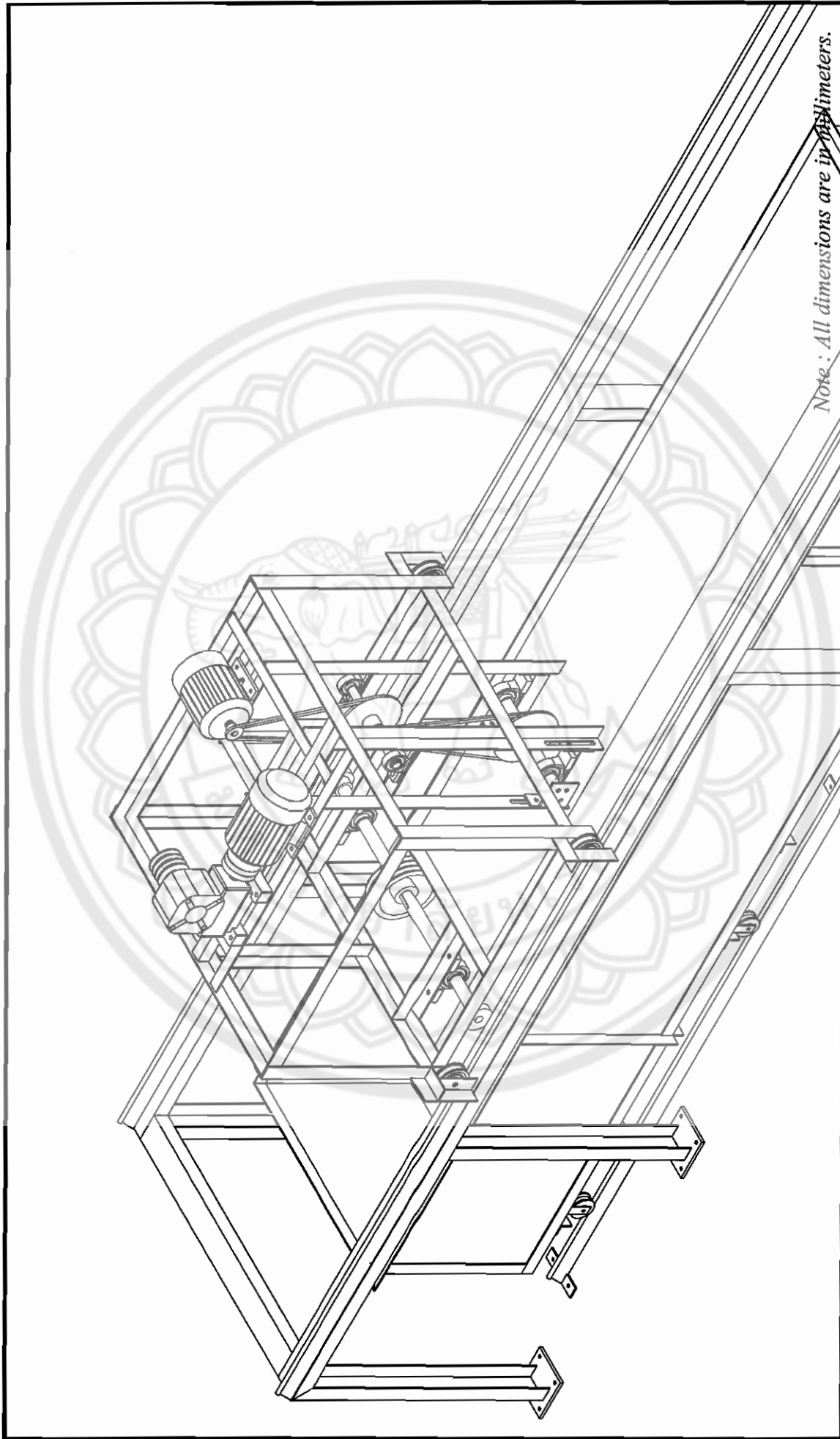

Note : All dimensions are in millimeters.

<p>PROJECT PLATE 03/32 SCALE 1:20</p>	<p>DATE 09/10/06 DN BY : NOPPORN SINTONG PANU THONGBOO PANUPAN BOONTON</p>	<p>ชุดทดสอบใบมีดจอบหมุน</p>	<p>FACULTY OF ENGINEERING NARESUAN UNIVERSITY</p>

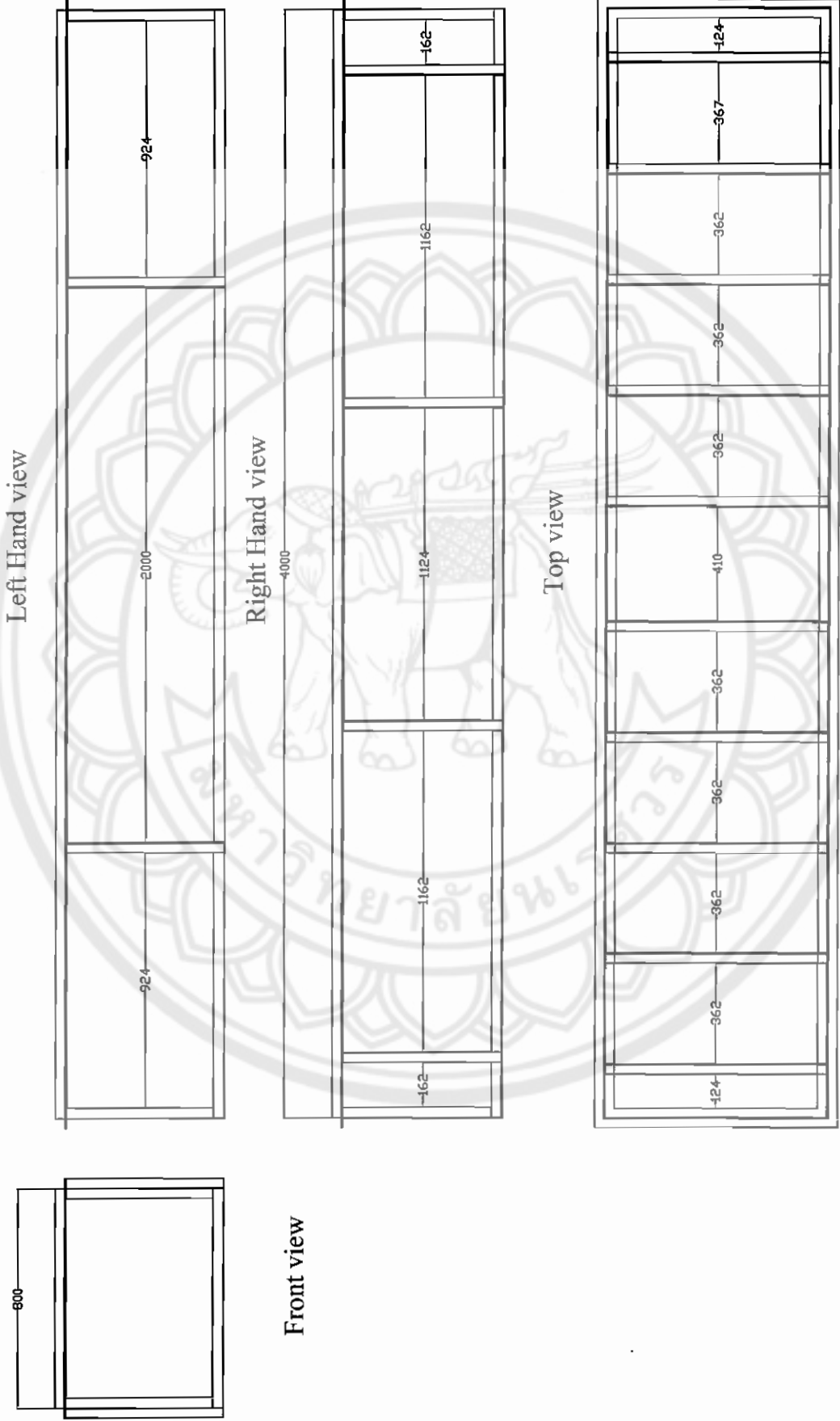

Note : All dimensions are in millimeters.

PROJECT	PLATE 04/32	SCALE 1:22
DATE 09/10/06	DN BY :	NOPORN SINYONG PANU THONGBOO PANUPAN BOONYON

โครงการบรรจุภัณฑ์

FACULTY OF ENGINEERING
 NARESUAN UNIVERSITY

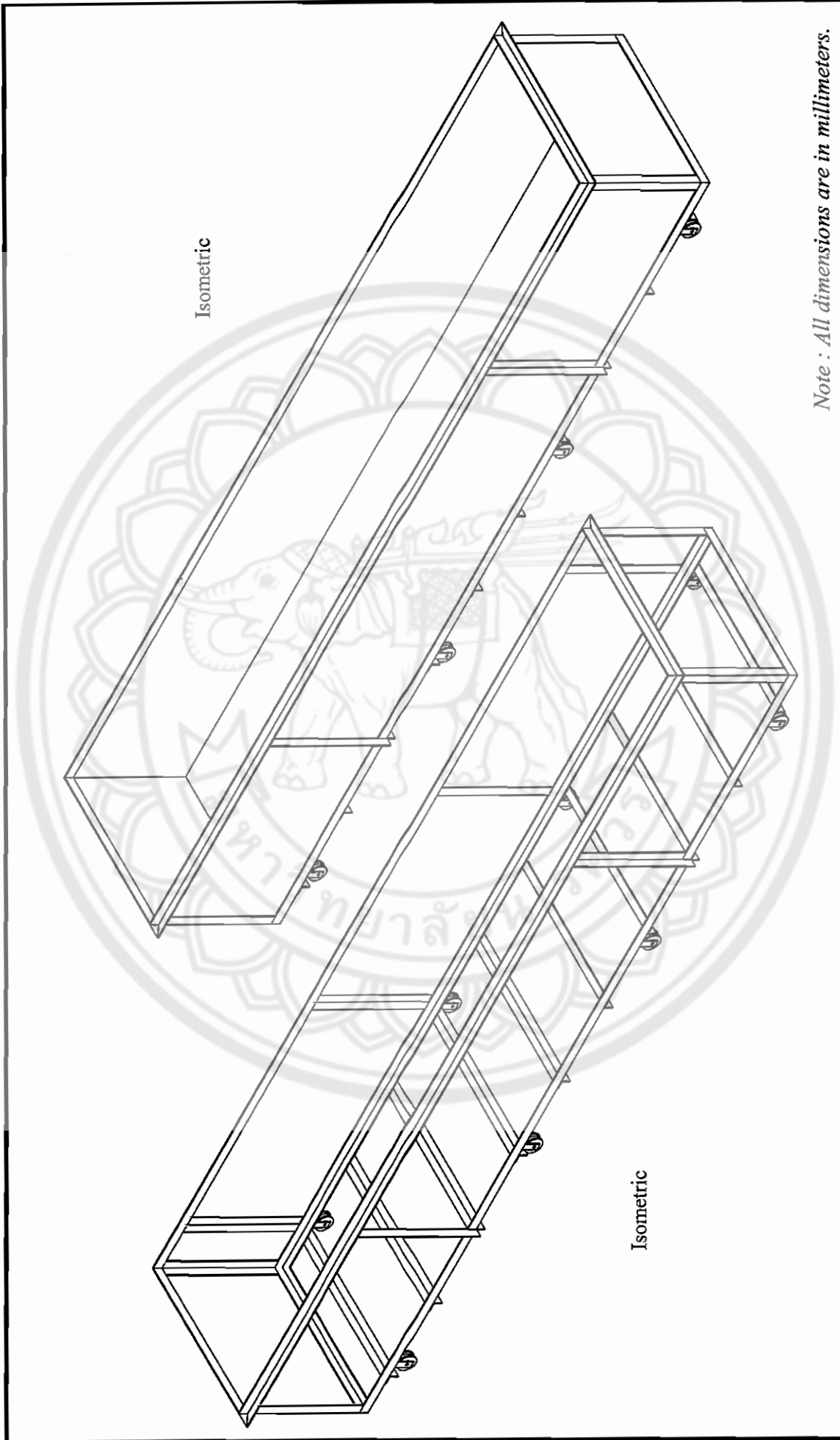

Note : All dimensions are in millimeters.

PROJECT	PLATE 05/32	SCALE 1:26
DATE 09/10/06	DN BY :	NOPPORN SINYONG PANU THONGBOO PANUPAN BOONTON

อภัยภูธร

FACULTY OF ENGINEERING
NARESUAN UNIVERSITY

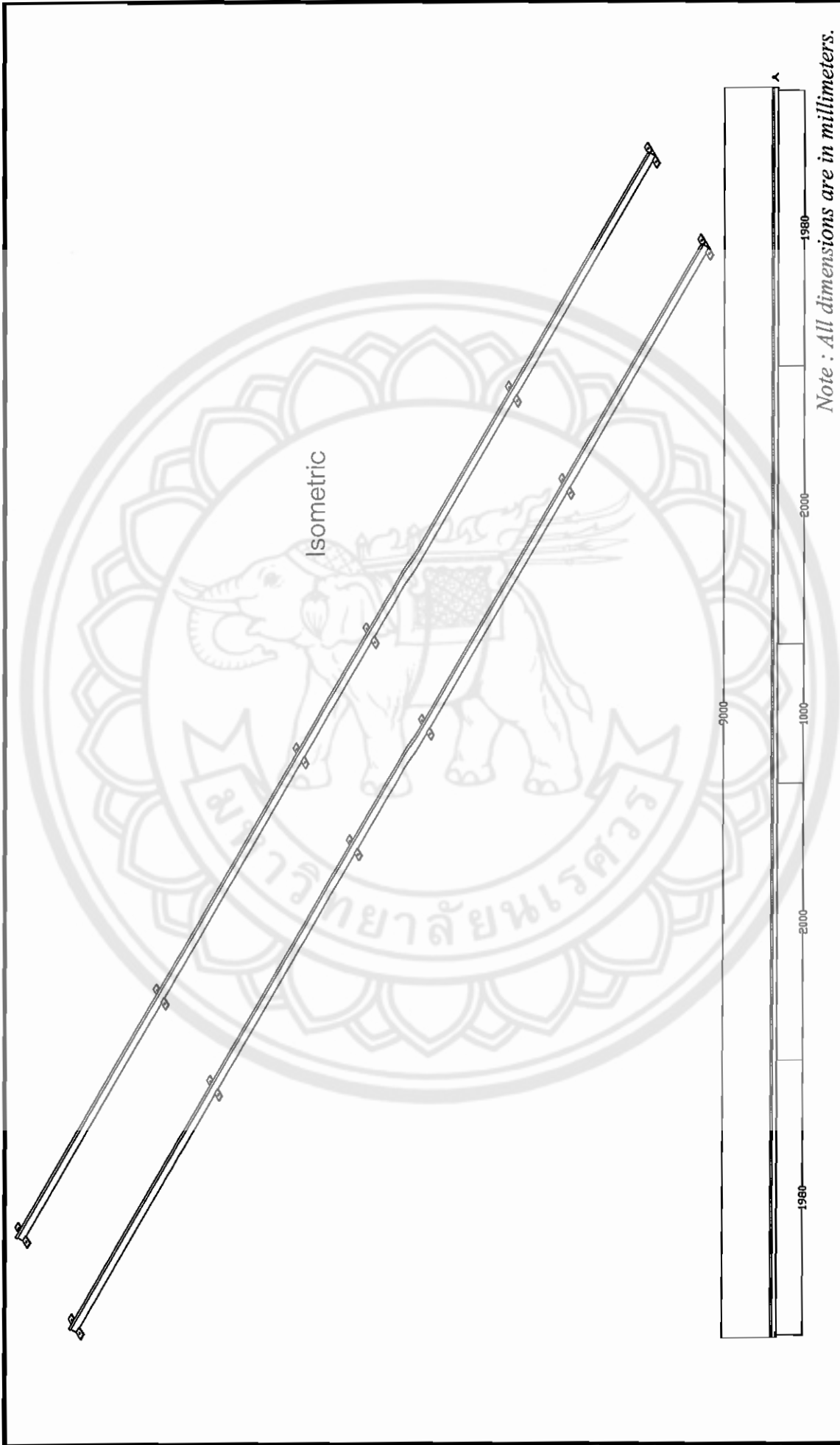

Note : All dimensions are in millimeters.

<p>PROJECT</p> <p>PLATE 06/32</p> <p>SCALE 1:40</p>	<p>DATE 09/10/06</p> <p>DN BY :</p> <p>NOPORN SINTONG PANU THONGBOO PANUPIN BOONTON</p>	<p>โรงเรียนเทพศิรินทร์</p>	<p>FACULTY OF ENGINEERING</p> <p>NARESUAN UNIVERSITY</p>
---	---	----------------------------	--

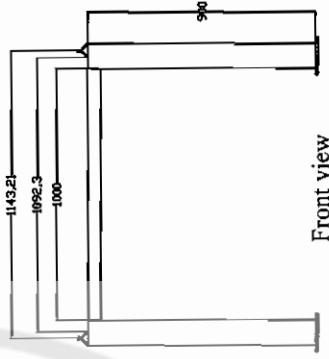
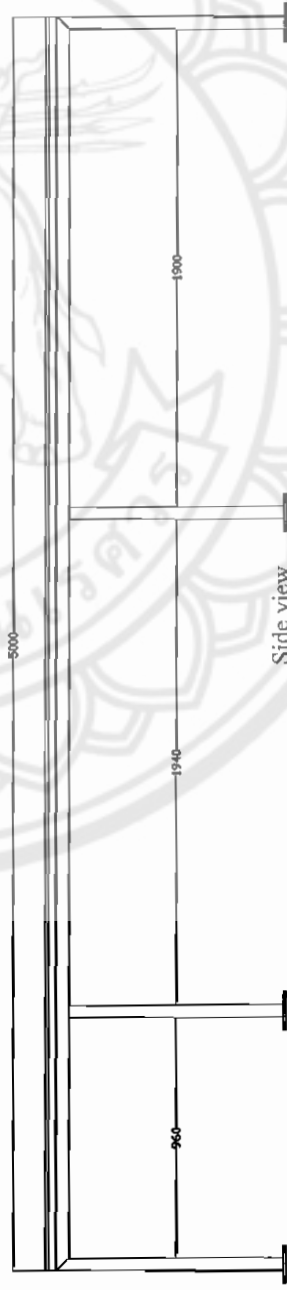
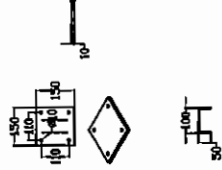
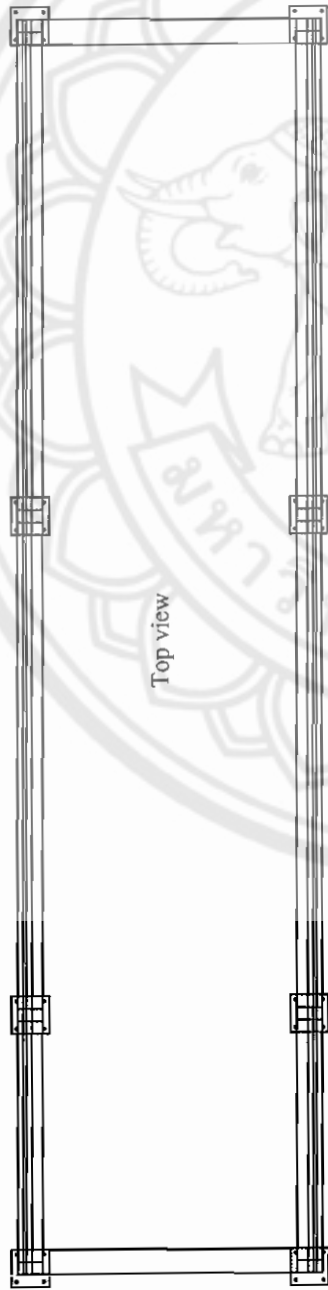

Note : All dimensions are in millimeters.

FACULTY OF ENGINEERING
 NARESUAN UNIVERSITY

ภาพ

PROJECT

PLATE 07/32 SCALE 1:30

DATE 09/10/06 DN BY :

NOPPORN SINYONG
 PANU THONGBOO
 PANUPAN BOONTON

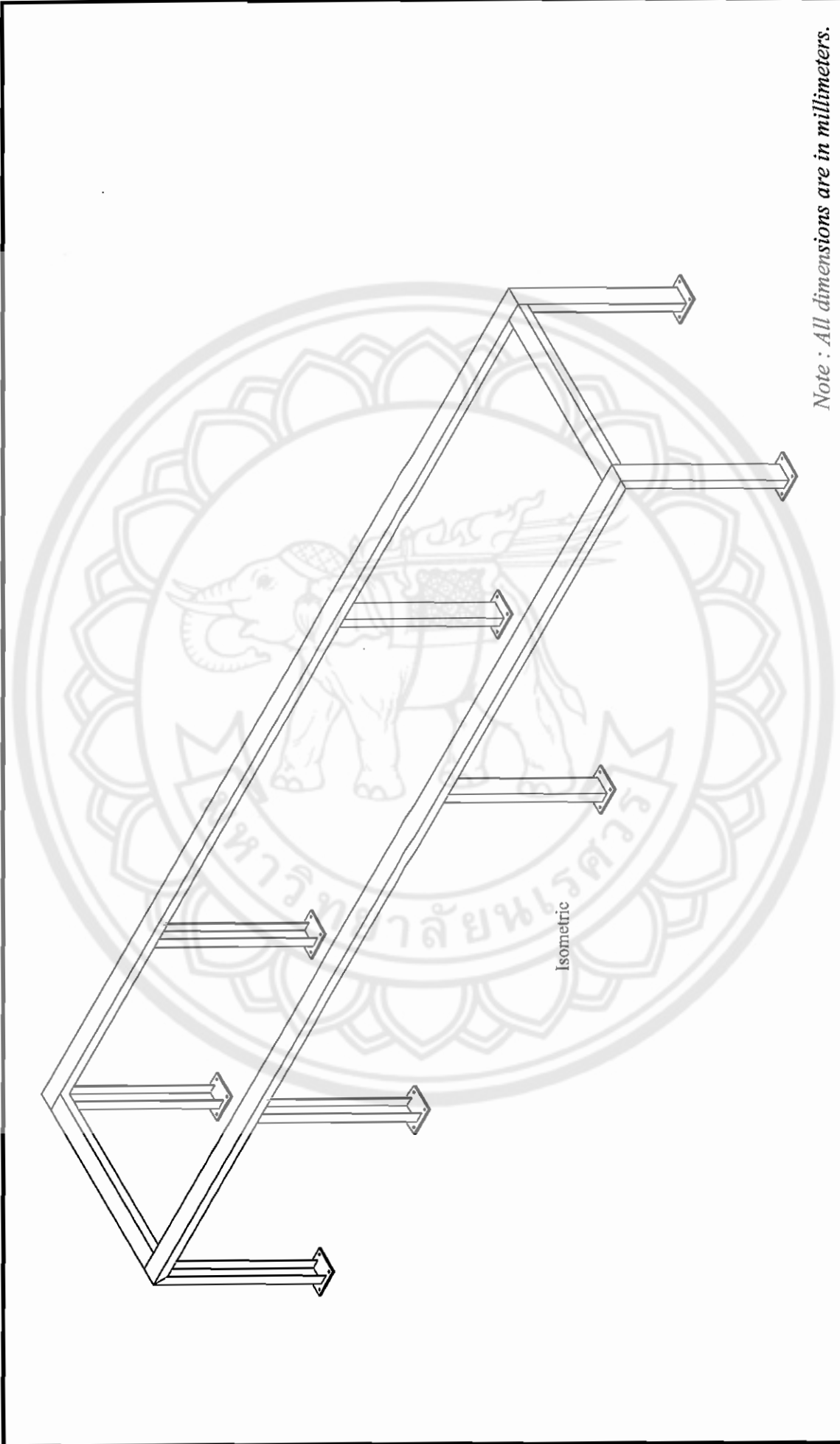

Note : All dimensions are in millimeters.

PROJECT	PLATE 08/32	SCALE 1:30
DATE 09/10/06	DN BY :	NOPPORN SINYONG PANU THONGBOO PANUPAN BOONYON

**FACULTY OF ENGINEERING
NARESUAN UNIVERSITY**

กาน

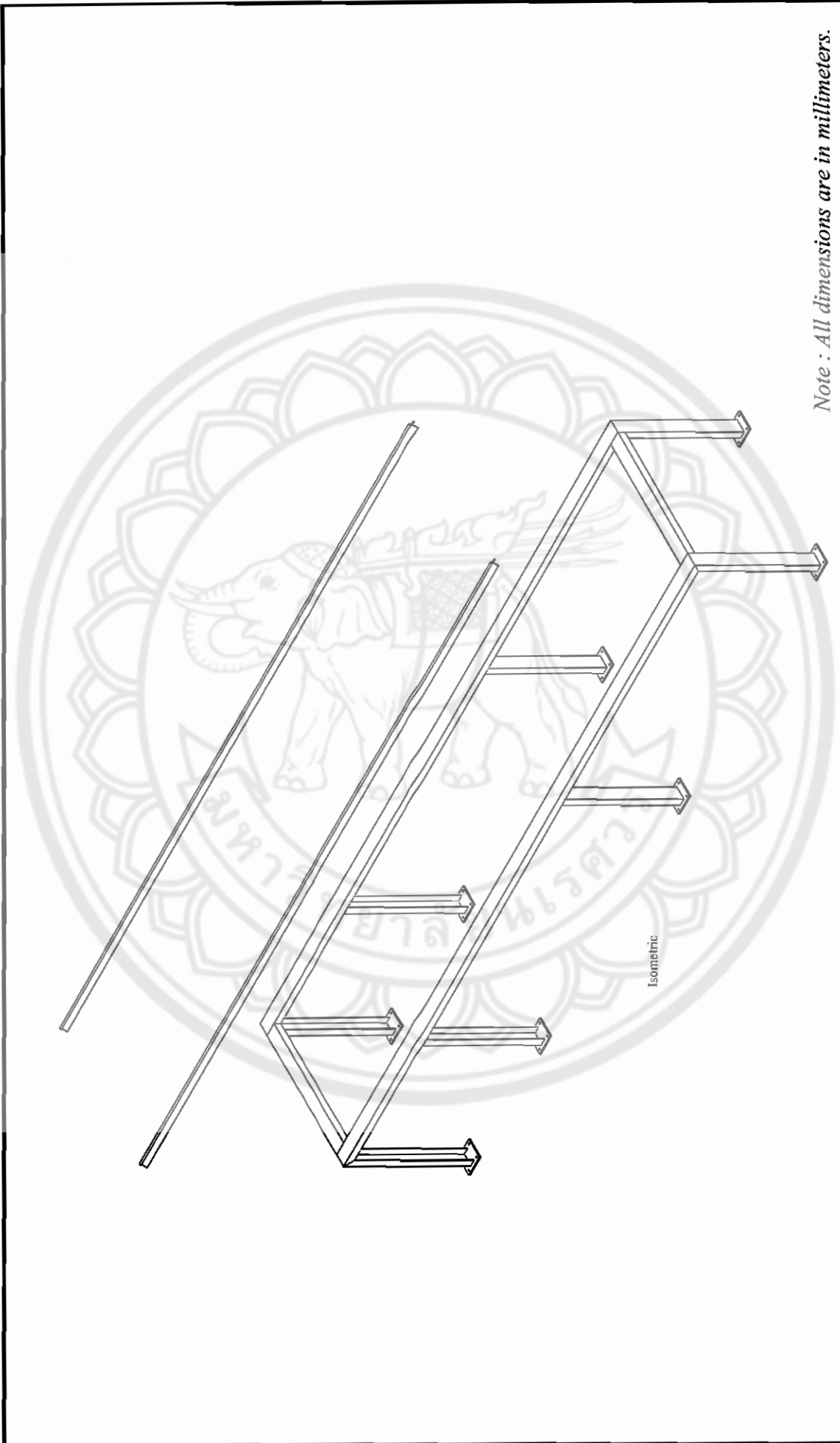

Note : All dimensions are in millimeters.

PROJECT	PLATE 09/32	ภาพ
SCALE 1:40	DATE 09/10/06	
DN BY :	NOPPORN SINYONG PANU THONGBOO PANUPAN BOONYON	
FACULTY OF ENGINEERING NARESUAN UNIVERSITY		

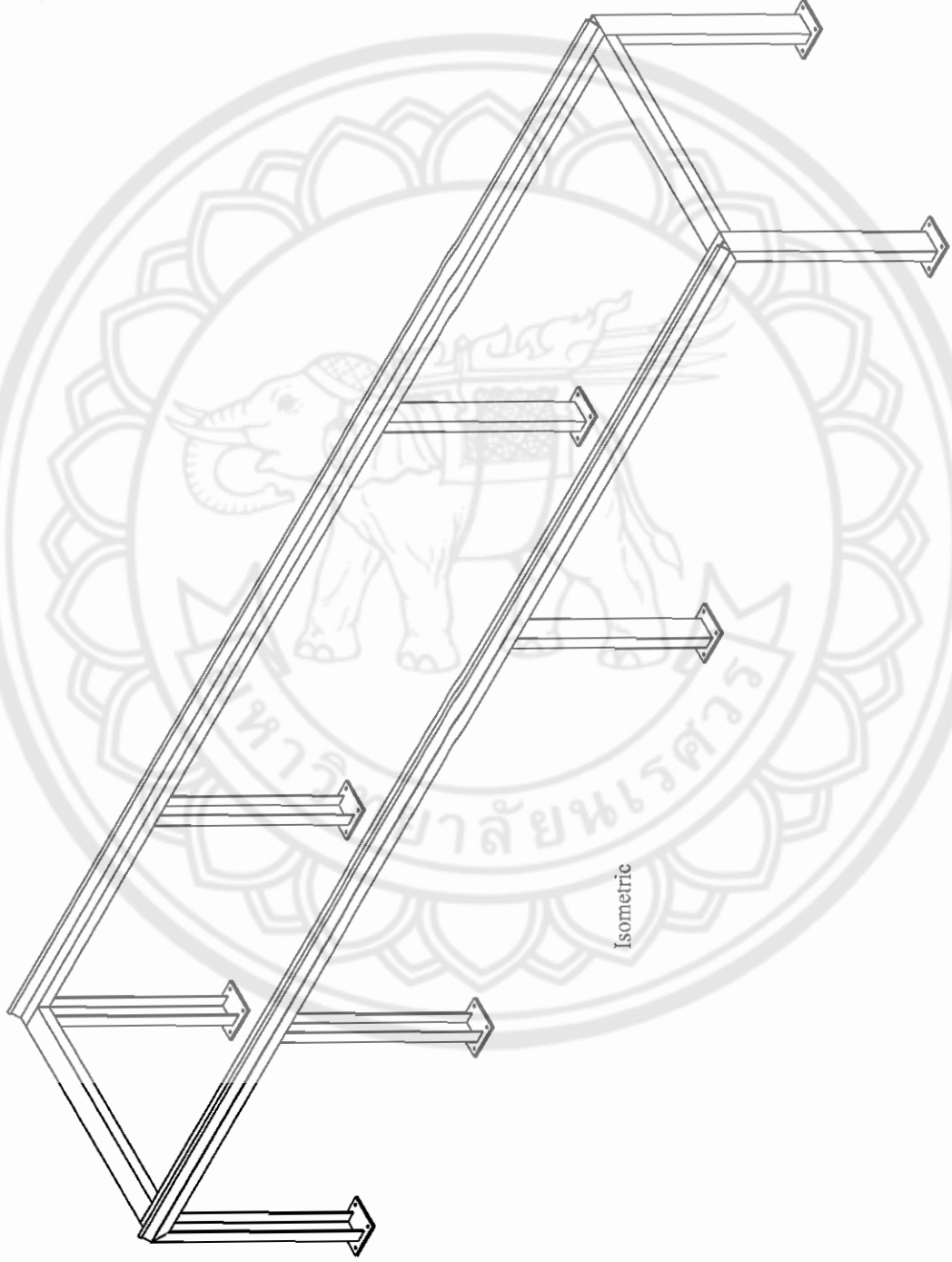

Note : All dimensions are in millimeters.

FACULTY OF ENGINEERING NARESUAN UNIVERSITY	ภาพ	PROJECT	PLATE 10/32	SCALE 1:30
		DATE 09/10/06	DN BY :	NOPPORN SINYONG PANU THONGBOO PANUPAN BOONTON

ฐานยึดมอเตอร์

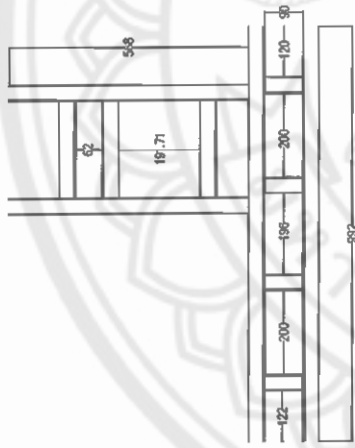

ฐานยึดเพลารับรถ

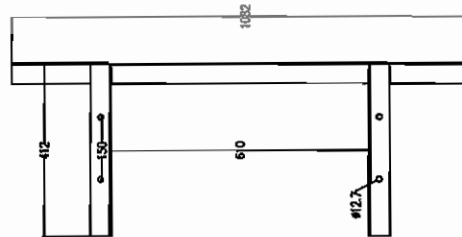

Top view

ฐานยึดเพลาทรงทอ



Note : All dimensions are in millimeters.

FACULTY OF ENGINEERING
NARESUAN UNIVERSITY

ไกรสรวิทย์

PROJECT

PLATE 11/32

SCALE 1:18

DATE 09/10/06

DN BY :
NOPPORN SINTONG
PANU THONGBOO
PANUPAN BOONTON

แขนยึดเพลาขับใบมีด

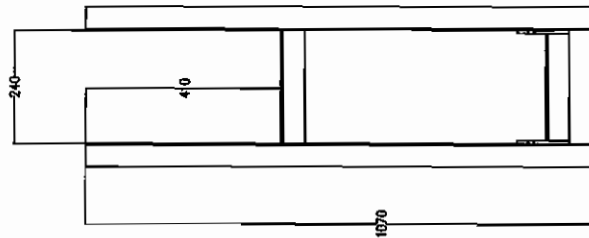

Side view

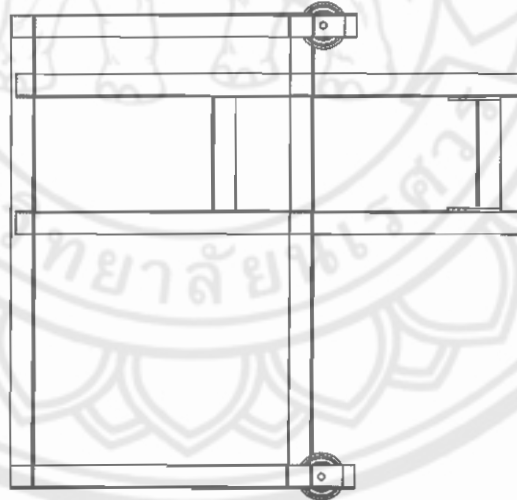

Front view

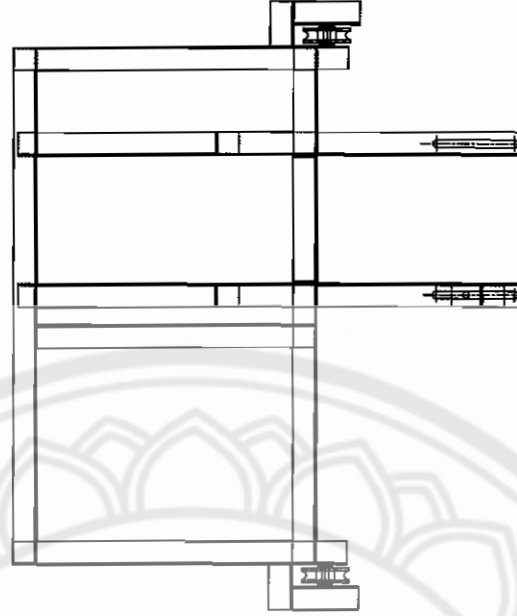

Note : All dimensions are in millimeters.

FACULTY OF ENGINEERING
NARESUAN UNIVERSITY

โคจรวิท

PROJECT PLATE 12/32 SCALE 1:16
DATE 09/10/06 DN BY :
NOFFORN SINTONG
PANU THONGBOO
PANUPAN BOONTON

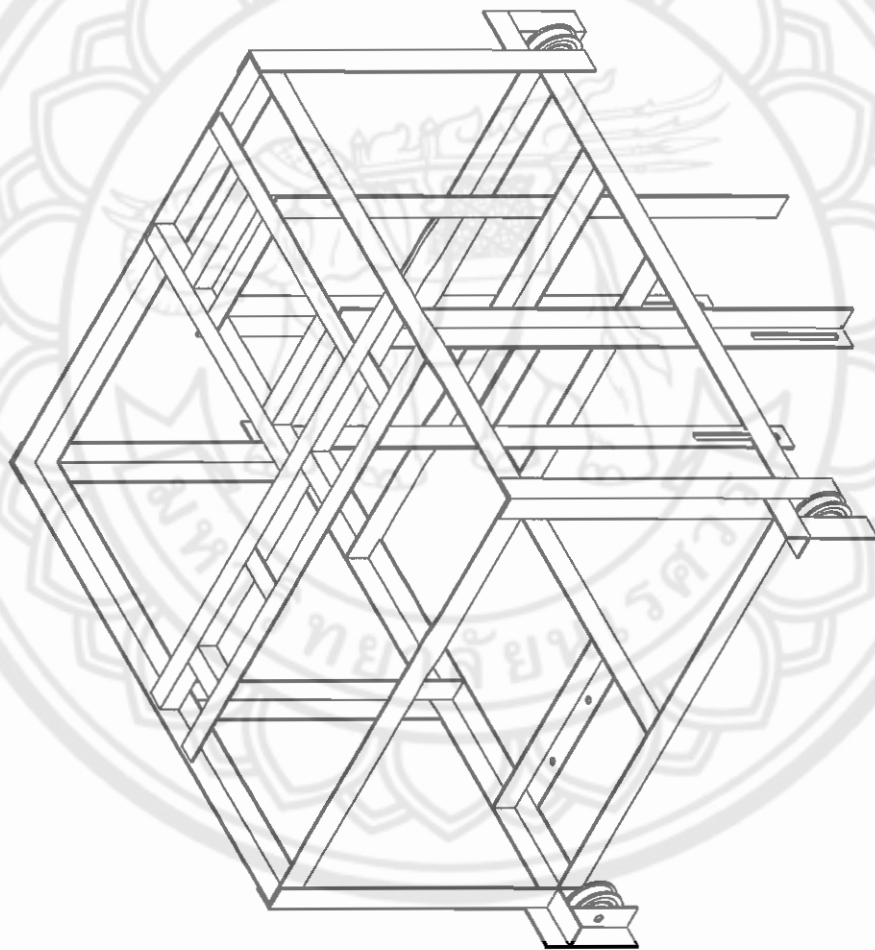

Isometric

Note : All dimensions are in millimeters.

FACULTY OF ENGINEERING
 NARESUAN UNIVERSITY

คำขวัญ

PROJECT

PLATE 13/32

SCALE 1:16

DATE 09/10/06

DN BY :
 NOPPORN SINYONG
 PANU THONGROO
 PANUPAN BOONTON

ลิ้ม

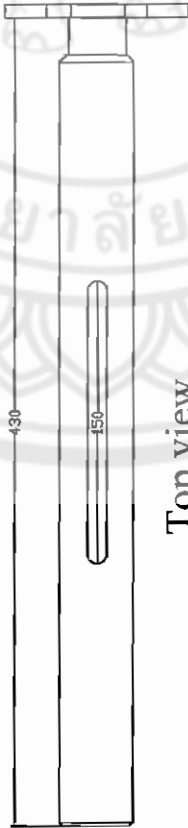
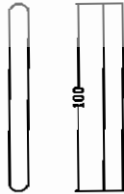

Top view

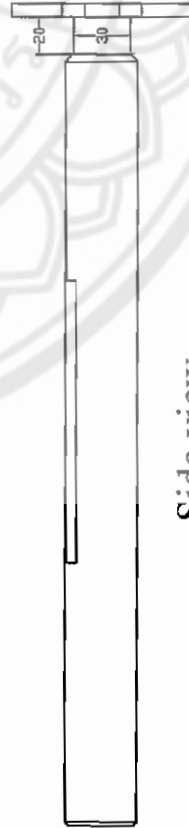

Side view

Isometric

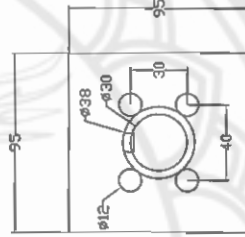
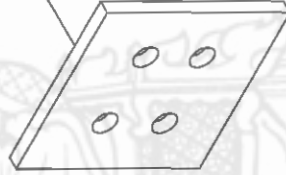
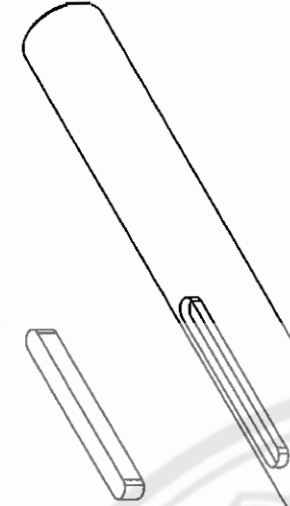

Front view

Note : All dimensions are in millimeters.

FACULTY OF ENGINEERING
NARESUAN UNIVERSITY

เพลาขับใบมีด

PROJECT

PLATE 14/32

SCALE 1:4

DATE 09/10/06

DN BY :
NOPPORN SINYONG
PANU THONGROO
PANUPAN BOONYON

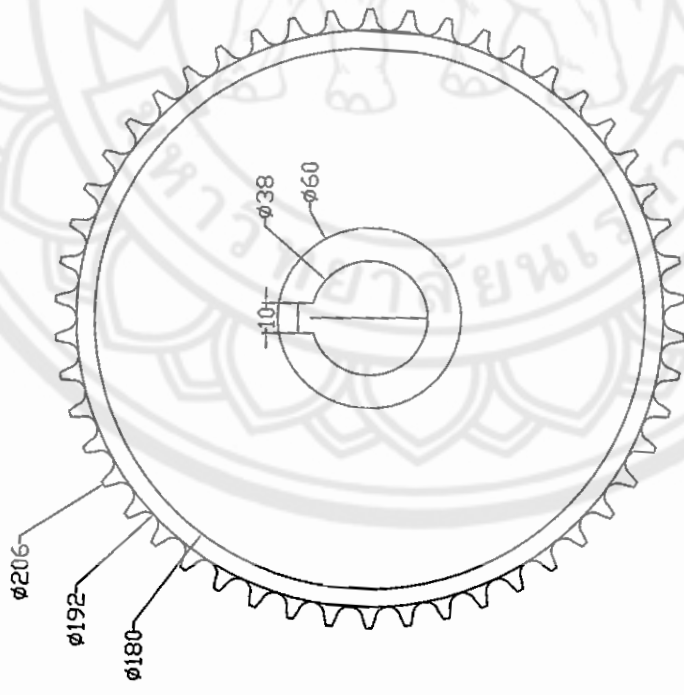

Front view

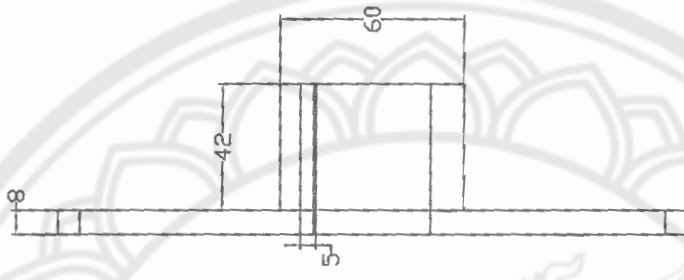

Side view

เพลารับใบมีด

Note : All dimensions are in millimeters.

FACULTY OF ENGINEERING
NARESUAN UNIVERSITY

สเตร์รับใบมีด

PROJECT	PLATE 15/32	SCALE 1:2.5
DATE 09/10/06	DN BY :	NOPORN SINTONG PANU THONGBOO PANUPAN BOONTON

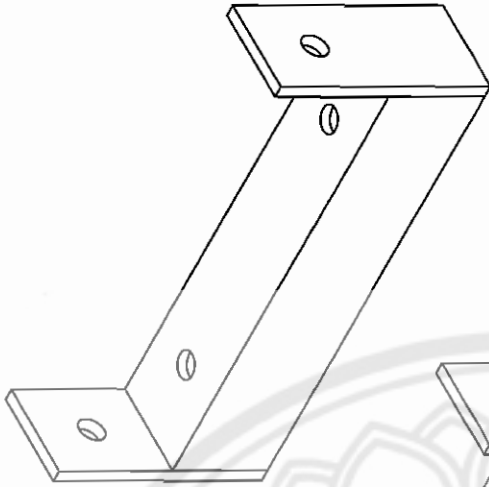

Isometric

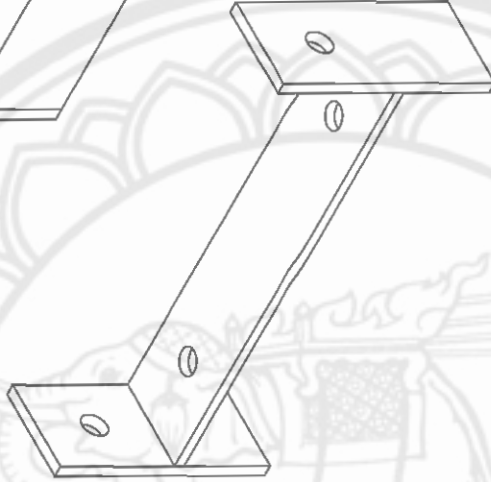

Side view

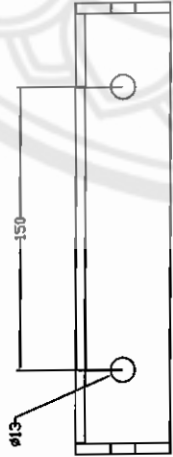

Top view

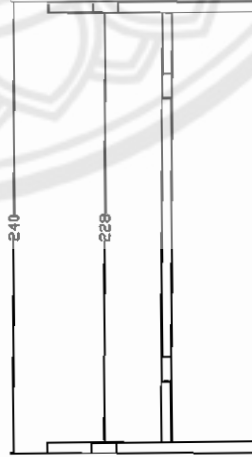

Front view

Note : All dimensions are in millimeters.

PROJECT PLATE 16/32 SCALE 1:4

NOFPORN SINYONG
PANU THONGBOO
PANUPAN BOONYON

DATE 09/10/06 DN BY :

งานยึดเพลาจับใบมีด

FACULTY OF ENGINEERING
NARESUAN UNIVERSITY

Top view

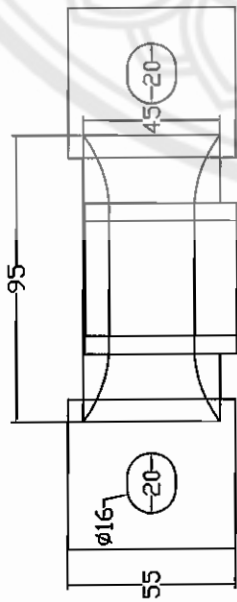

Front view

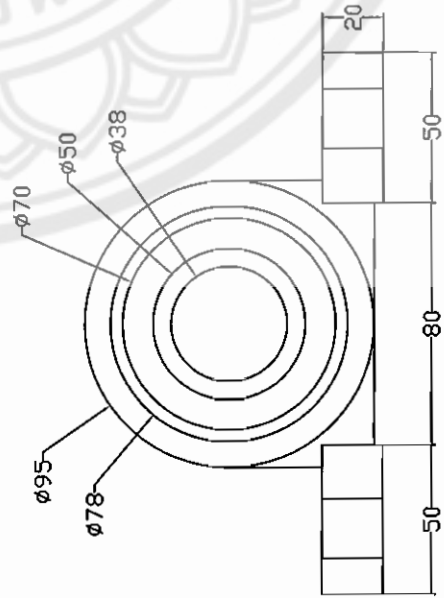

Isometric



Side view

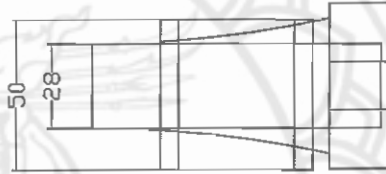

Note : All dimensions are in millimeters.

FACULTY OF ENGINEERING
NARESUAN UNIVERSITY

ชุดถูกป็นยึดเพลานใบมีด

PROJECT

PLATE 17/32

SCALE 1:2.5

DATE 09/10/06 DN BY :

NOFPORN SINTONG
PANU THONGBOO
PANUPAN BOONTON

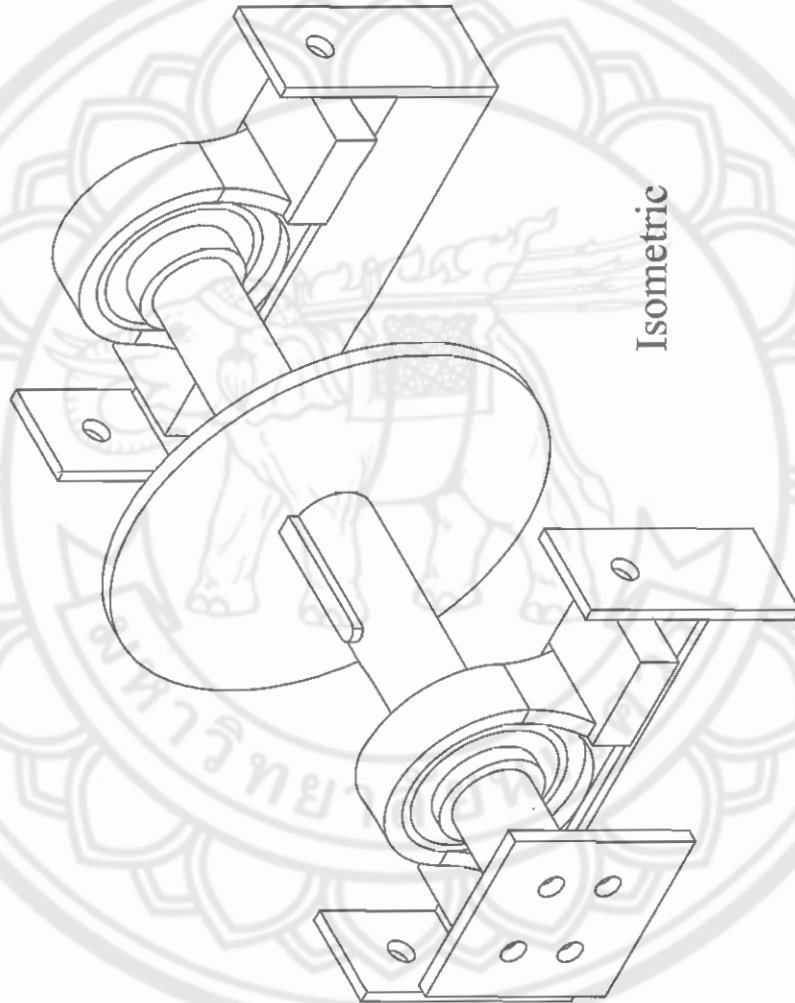

Isometric

Note : All dimensions are in millimeters.

<p>FACULTY OF ENGINEERING NARESUAN UNIVERSITY</p>	<p>เพล่าขับใบมีด</p>	<p>PROJECT</p>	<p>PLATE 18/32</p>	<p>SCALE 1:4</p>
		<p>LATE 09/10/06</p>	<p>DN BY :</p>	<p>NOPPORN SINYONG PANU THONGBOO PANUPAN BOONYON</p>

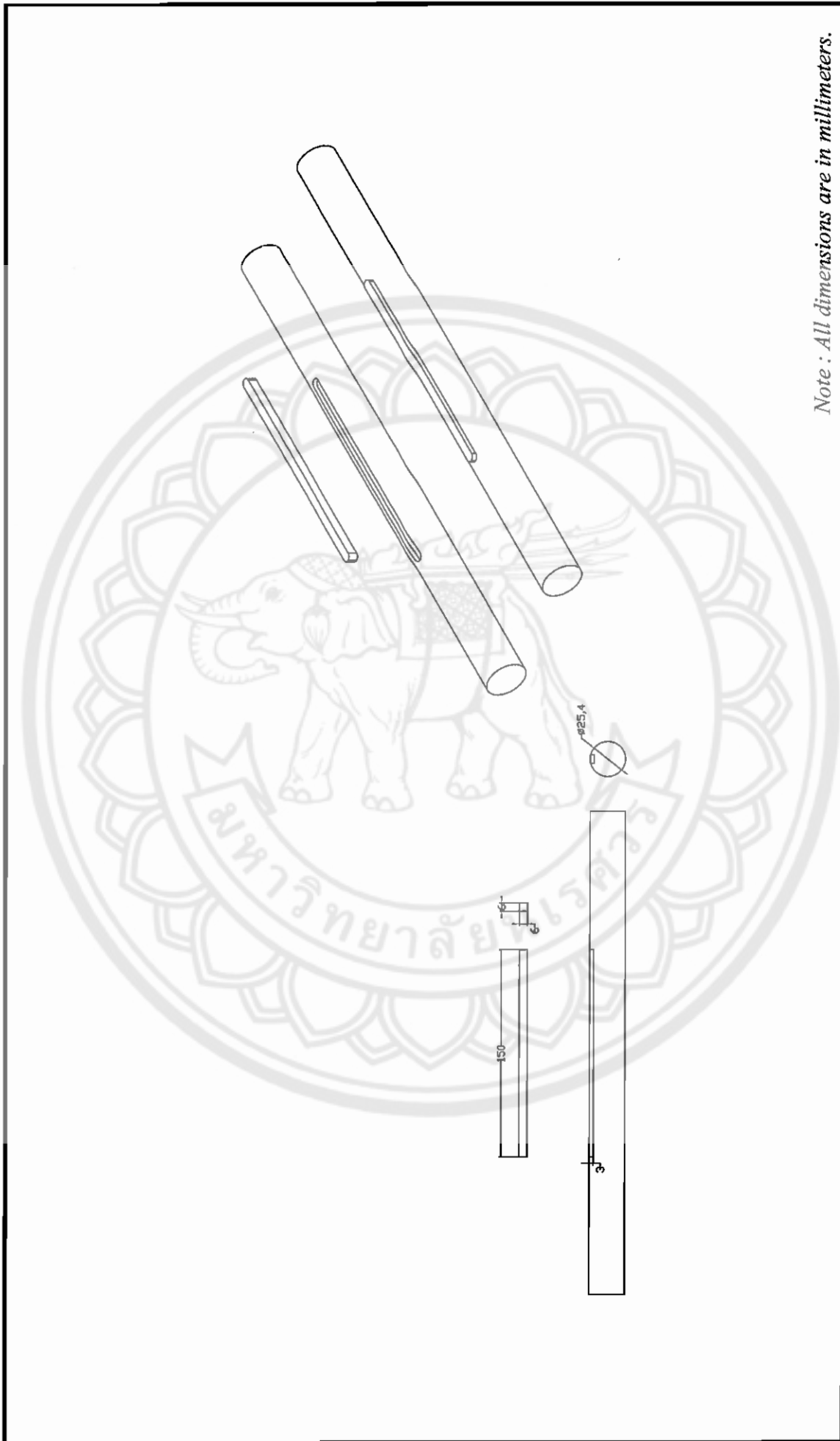

Note : All dimensions are in millimeters.

PROJECT	PLATE 19/32	เฟืองชุดเฟืองทด FACULTY OF ENGINEERING NARESUAN UNIVERSITY
DATE 09/10/06	DN BY : NOPPORN SINYONG PANU THONGBOO PANUPAN BOONTON	

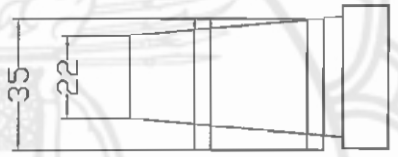
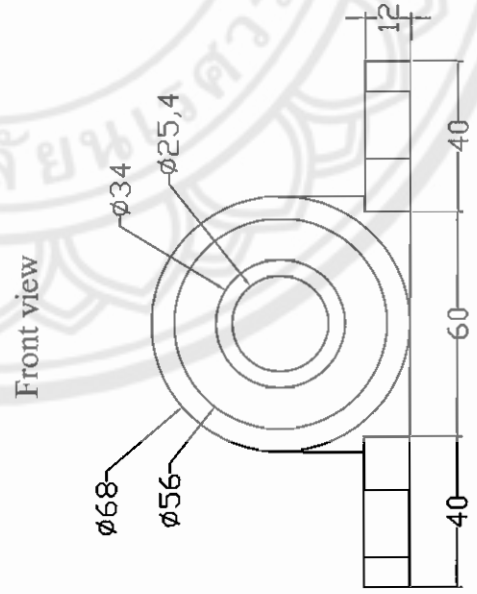
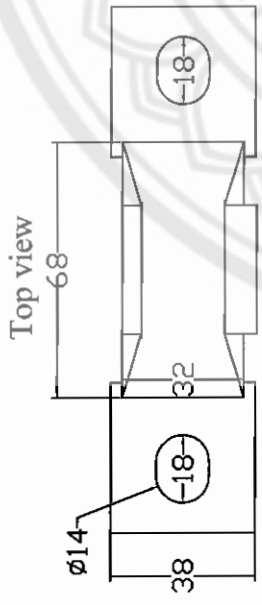

Note : All dimensions are in millimeters.

FACULTY OF ENGINEERING
NARESUAN UNIVERSITY

ชุดอุปกรณ์ยึดเพลาทดรอบ

PROJECT

PLATE 20/32

SCALE 1:2

DATE 09/10/06

DN BY :
NOPPORN SINTONG
PANU THONGROO
PANUPAN BOONTON

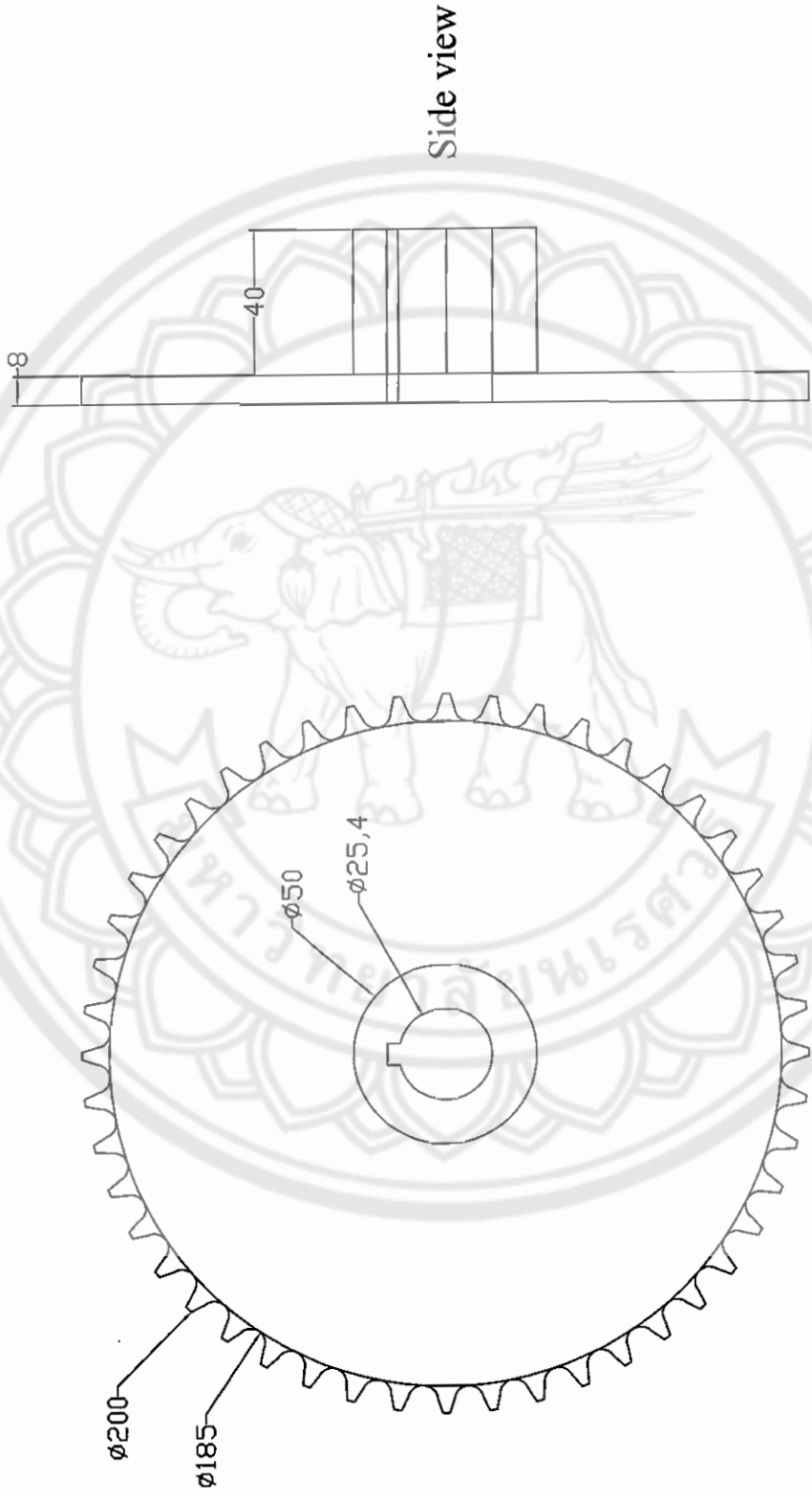

Side view

Front view

Note : All dimensions are in millimeters.

PROJECT	PLATE 21/32	SCALE 1:2
DATE 09/10/06	DN BY : NOPORN SINYONG PANU THONGBOO PANUPAN BOONTON	<p style="text-align: center;">สเด็จพระนครป</p> <p style="text-align: center;">FACULTY OF ENGINEERING NARESUAN UNIVERSITY</p>

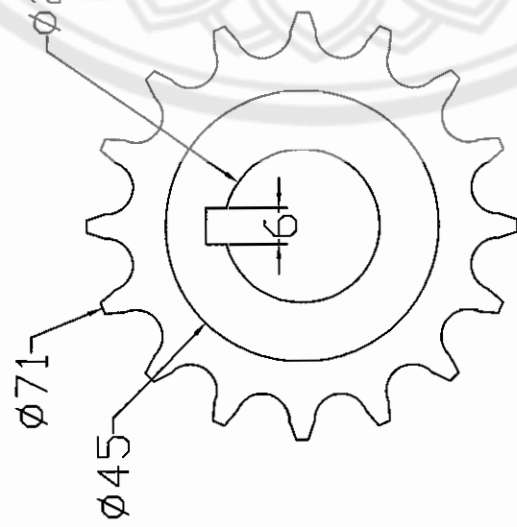

Front view

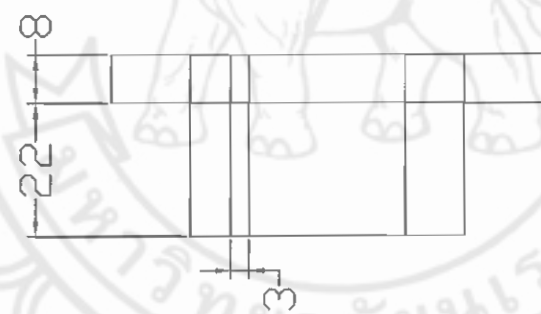

Side view

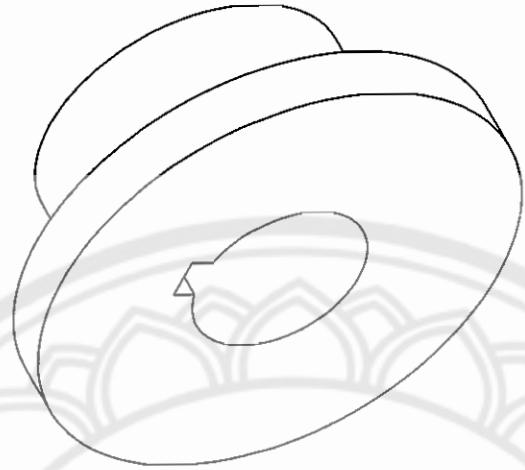

Isometric

Note : All dimensions are in millimeters.

<p>FACULTY OF ENGINEERING NARESUAN UNIVERSITY</p>	<p>ศาสตราจารย์ดร.ออบ</p>	<p>PROJECT PLATE 22/32</p>	<p>SCALE 1:1.25</p>
		<p>DATE 09/10/06</p>	<p>DN BY : NOPPORN SINTONG PANU THONGBOO PANUPAN BOONYON</p>

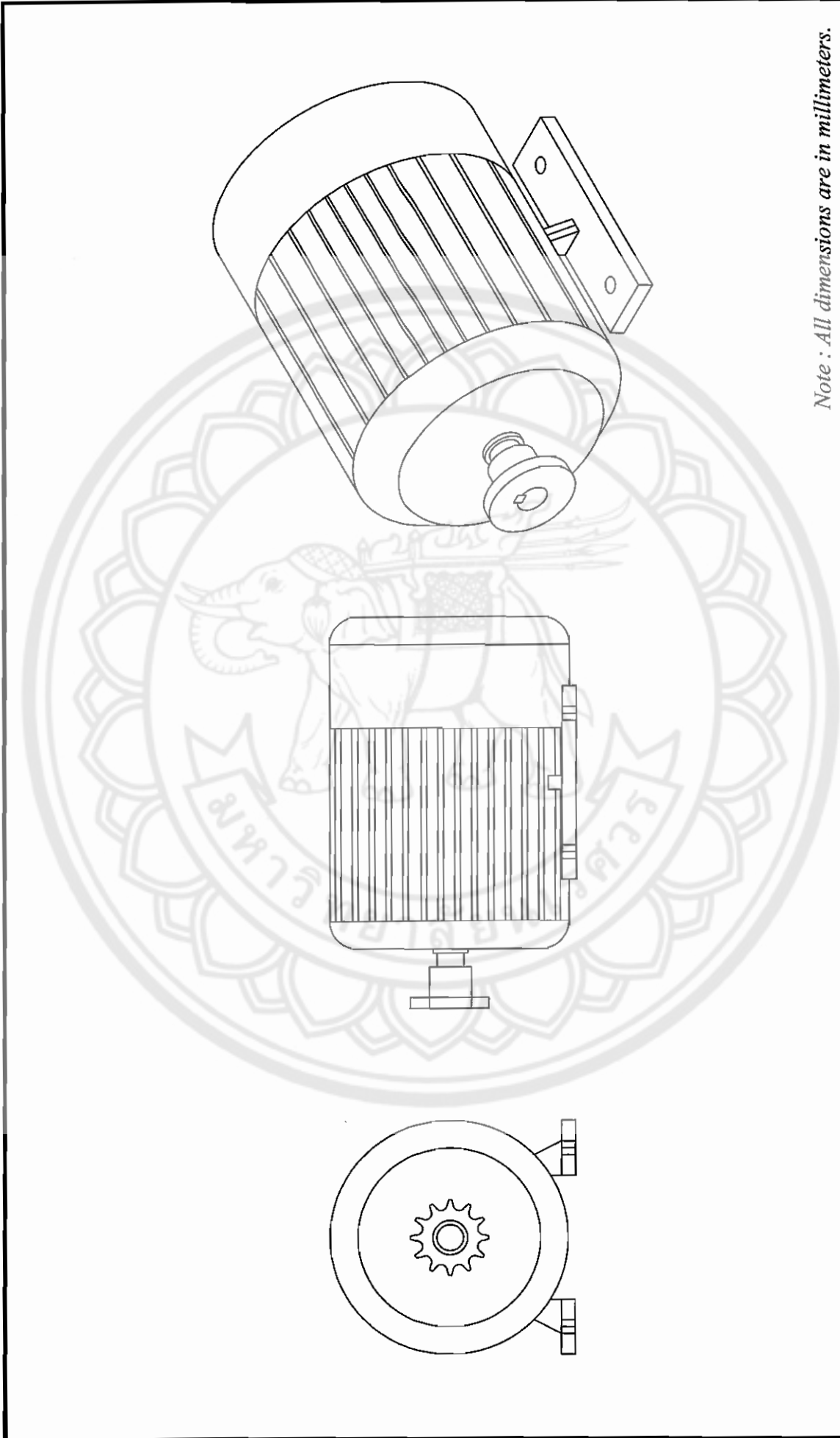

Note : All dimensions are in millimeters.

<p>PROJECT</p> <p>DATE 09/10/06</p>	<p>PLATE 23/32</p> <p>DN BY :</p>	<p>SCALE 1:4</p> <p>NOPORN SINTONG PANU THONGBOO PANUPAN BOONTON</p>
<p>มอเตอร์ขับใบมีด</p>		
<p>FACULTY OF ENGINEERING NARESUAN UNIVERSITY</p>		

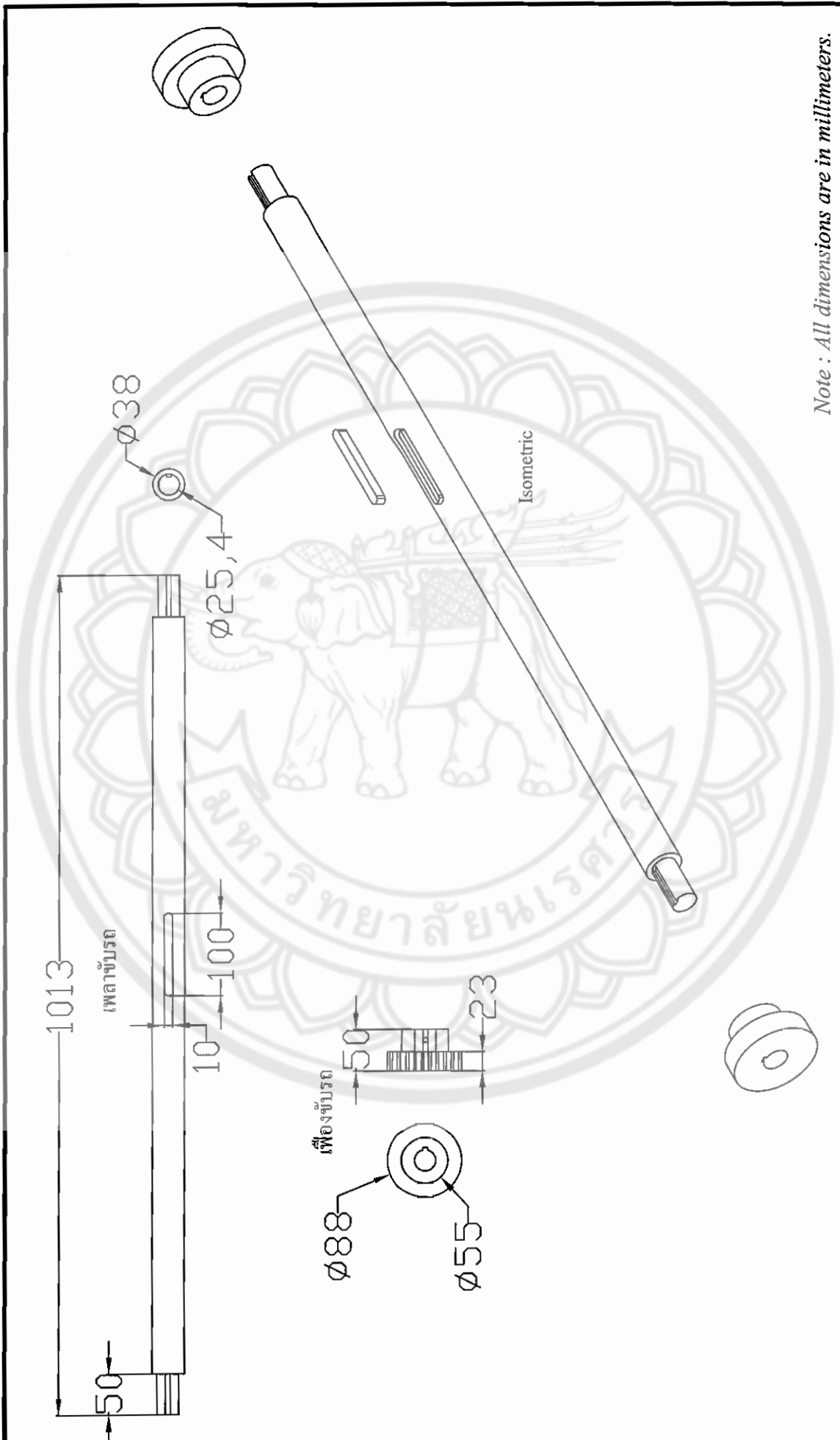

Note : All dimensions are in millimeters.

FACULTY OF ENGINEERING NARESUAN UNIVERSITY	เพลาขับตัวรถ		PROJECT PLATE 24/32	SCALE 1:7
	DATE 09/10/06	DN BY : NOPPORN SINTONG PANU THONGBOO PANUPAN BOONYON		

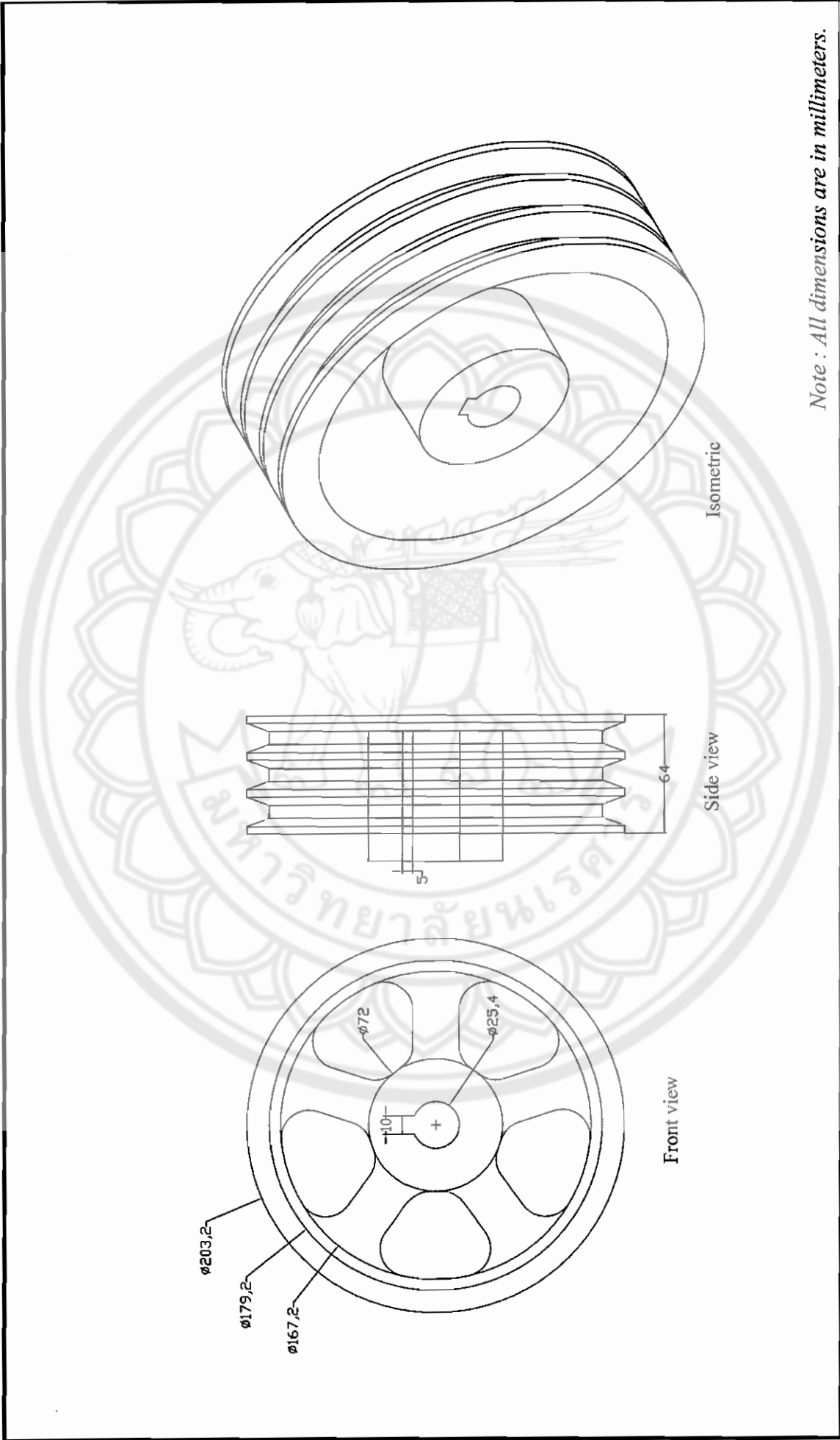

Note : All dimensions are in millimeters.

<p>PROJECT</p>	<p>PLATE 25/32</p>	<p>SCALE 1:3</p>
<p>พุดเลย์ขับเพลลาขับเคลื่อน</p>		
<p>FACULTY OF ENGINEERING NARESUAN UNIVERSITY</p>	<p>DATE 09/10/06</p>	<p>DN BY : NOPPORN SINTONG PANU THONGBOO PANUPAN BOONYON</p>

Side view

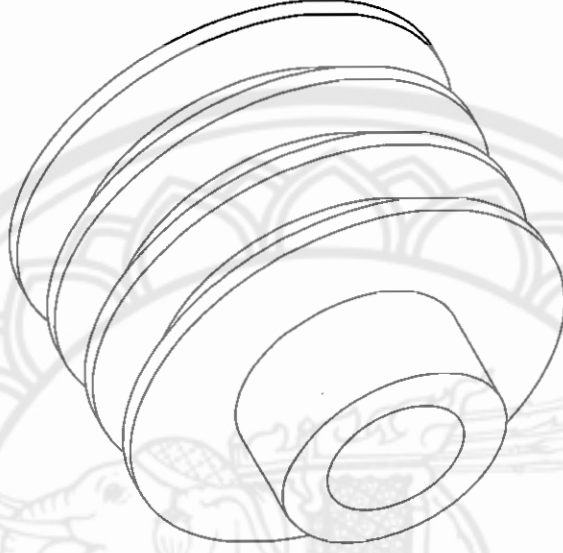
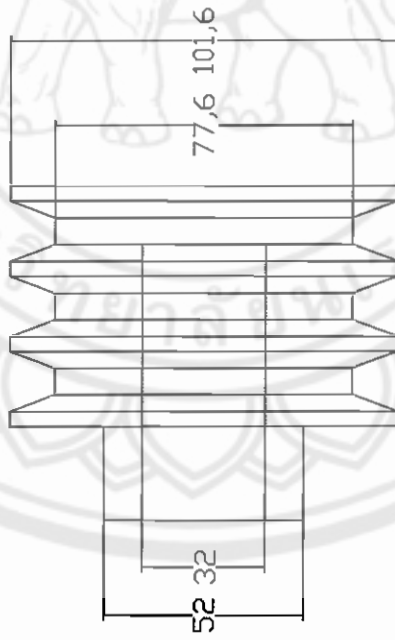

Isometric

Note : All dimensions are in millimeters.

FACULTY OF ENGINEERING
NARESUAN UNIVERSITY

พุลเลย์

PROJECT

PLATE 26/32

SCALE 1:43

DATE 09/10/06

DN BY :
NOPPORN SINTONG
PANU THONGBOO
PANUPAN BOONTON

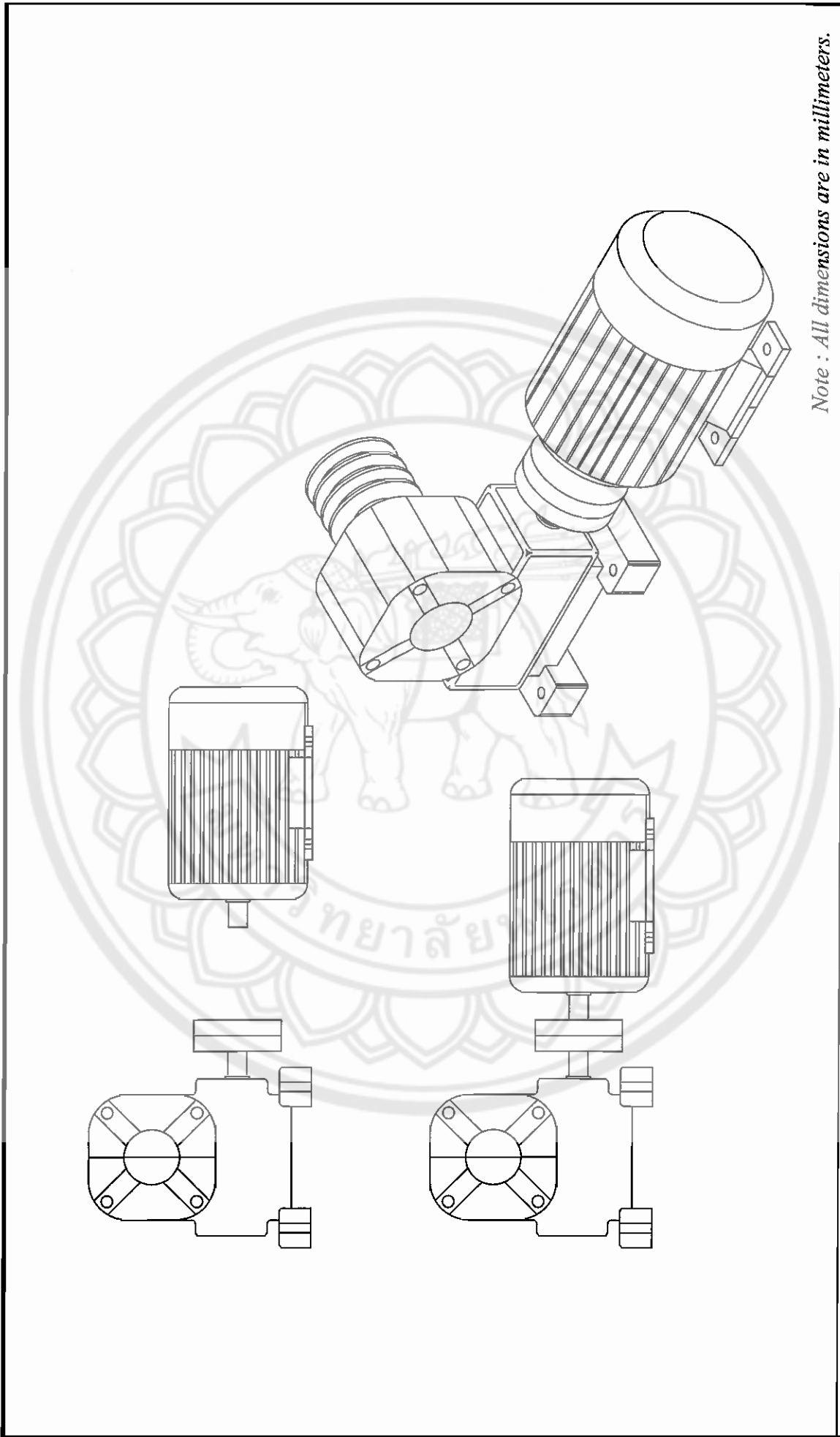

Note : All dimensions are in millimeters.

<p>FACULTY OF ENGINEERING NARESUAN UNIVERSITY</p>	<p>ชุดมอเตอร์ปั๊ม</p>	<p>PROJECT</p>	<p>PLATE 27/32</p>	<p>SCALE 1:7</p>
		<p>DATE 09/10/06</p>	<p>DN BY :</p>	<p>NOFFORN SINYONG PANU THONGBOO PANUPAN BOONTON</p>

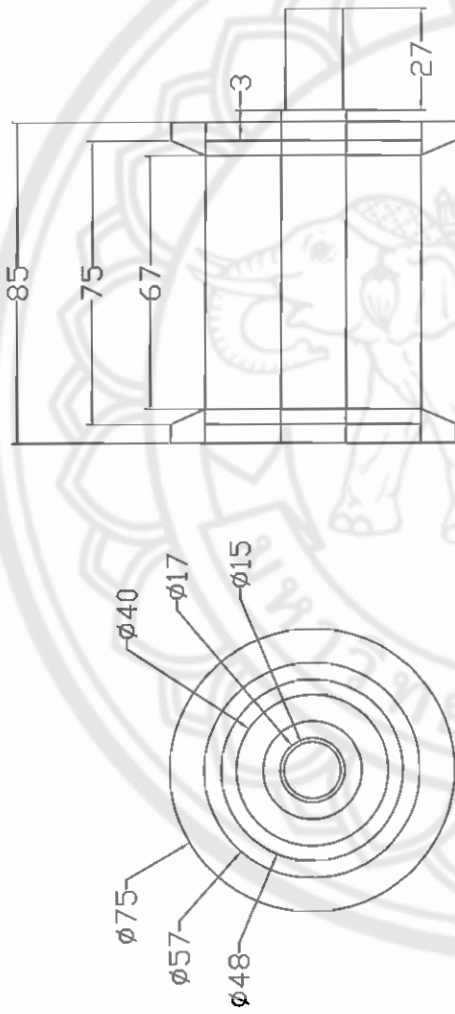

Front view

Side view

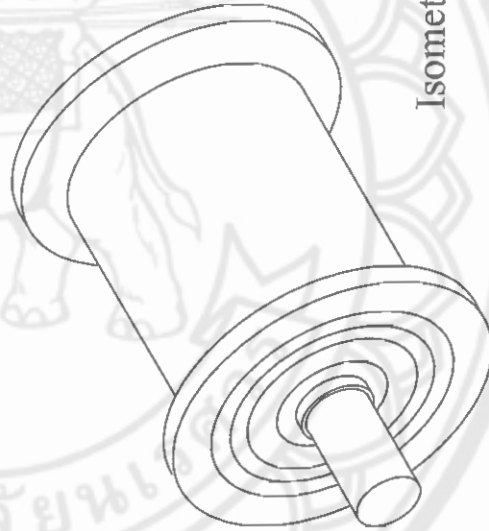

Isometric

Note : All dimensions are in millimeters.

FACULTY OF ENGINEERING
NARESUAN UNIVERSITY

ลูกตั้งสายพาน

PROJECT

PLATE 28/32

SCALE 1:2

DATE 09/10/06

DN BY :

NOPORN SINYONG
PANU THONGBOO
PANUPAN BOONYON

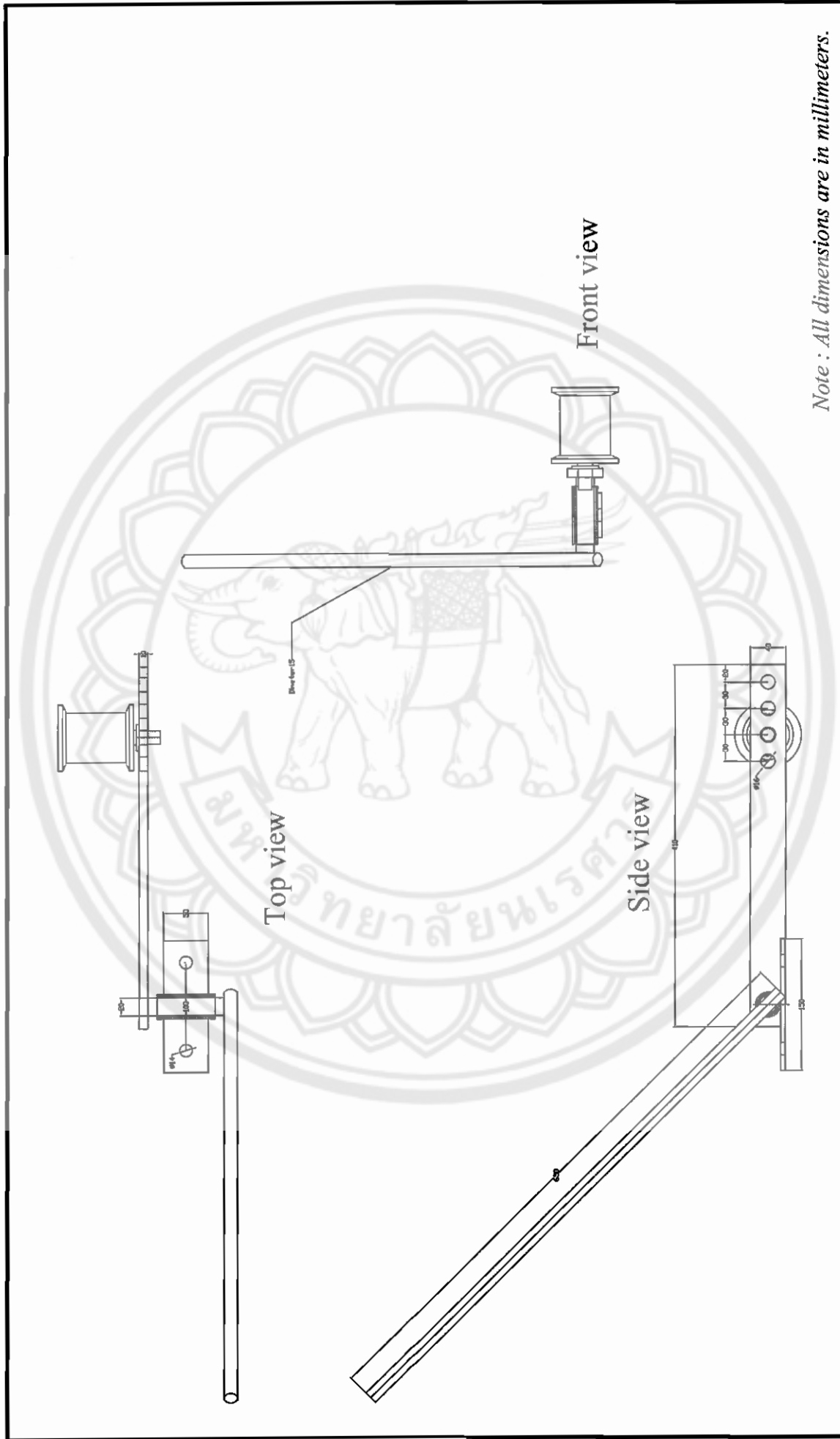

Note : All dimensions are in millimeters.

FACULTY OF ENGINEERING
NARESUAN UNIVERSITY

ชุดลูกต้อตึงสายพาน

PROJECT

PLATE 29/32

SCALE 1:6.25

DATE 09/10/06 DN BY :

NOPORN SINYONG
PANU THONGBOO
PANUPAN BOONYON

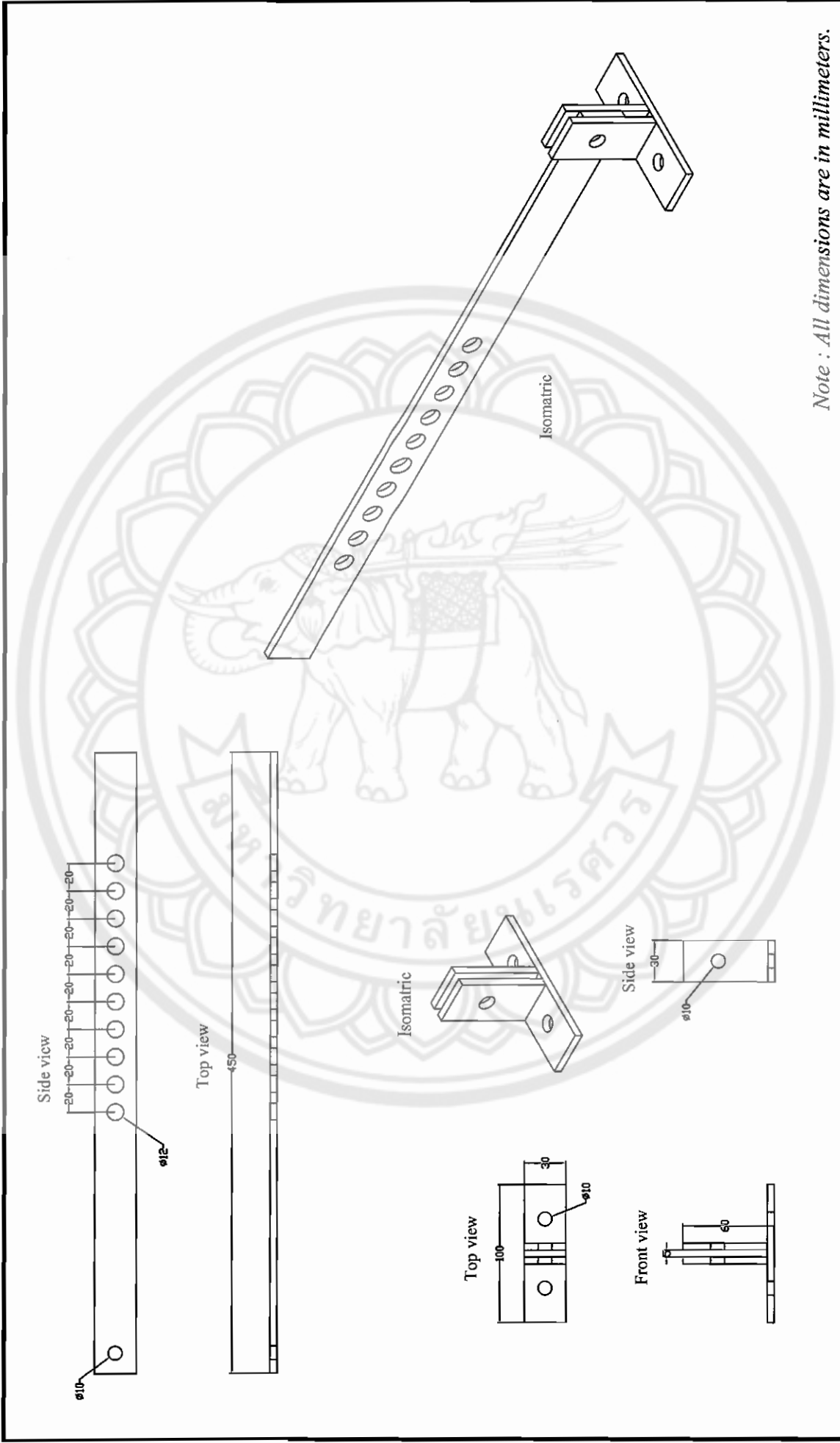

Note : All dimensions are in millimeters.

แผนจับชุดตั้งโต๊ะ	PROJECT	PLATE 30/32	SCALE 1:4
	DATE 09/10/06	DN BY :	NOPPORN SINTONG PANU THONGBOO PANUPAN BOONTON
FACULTY OF ENGINEERING NARESUAN UNIVERSITY			

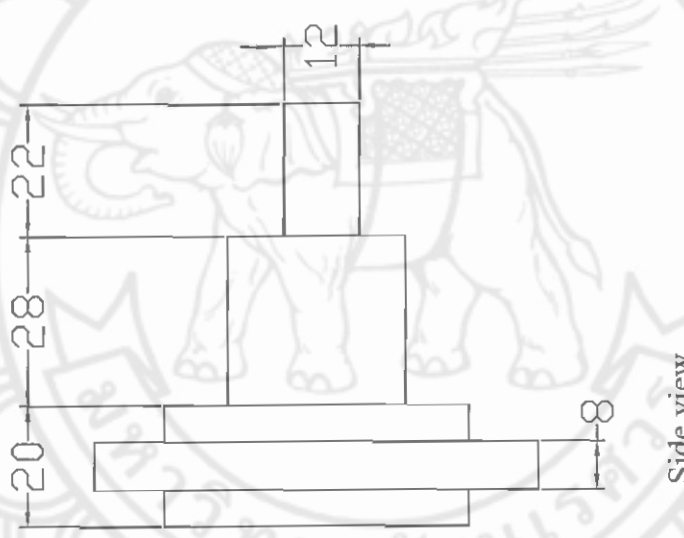
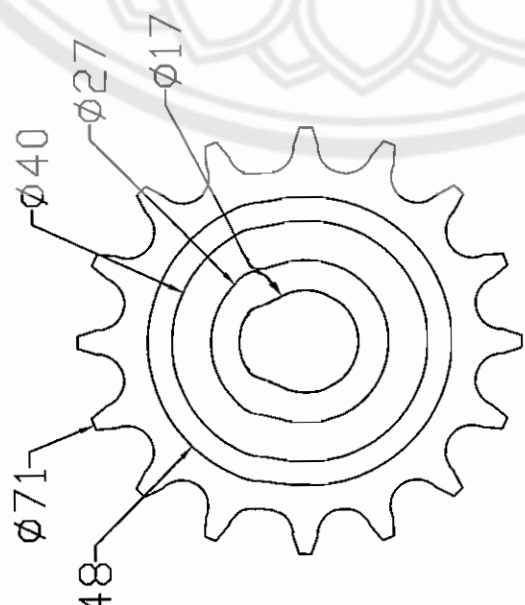

Note : All dimensions are in millimeters.

FACULTY OF ENGINEERING
NARESUAN UNIVERSITY

สเตอริงโซ่

PROJECT

PLATE 31/32

SCALE 1:1.25 8

DATE 09/10/06

DN BY :
NOPORN SINYONG
PANU THONGBOO
PANUPAN BOONYON

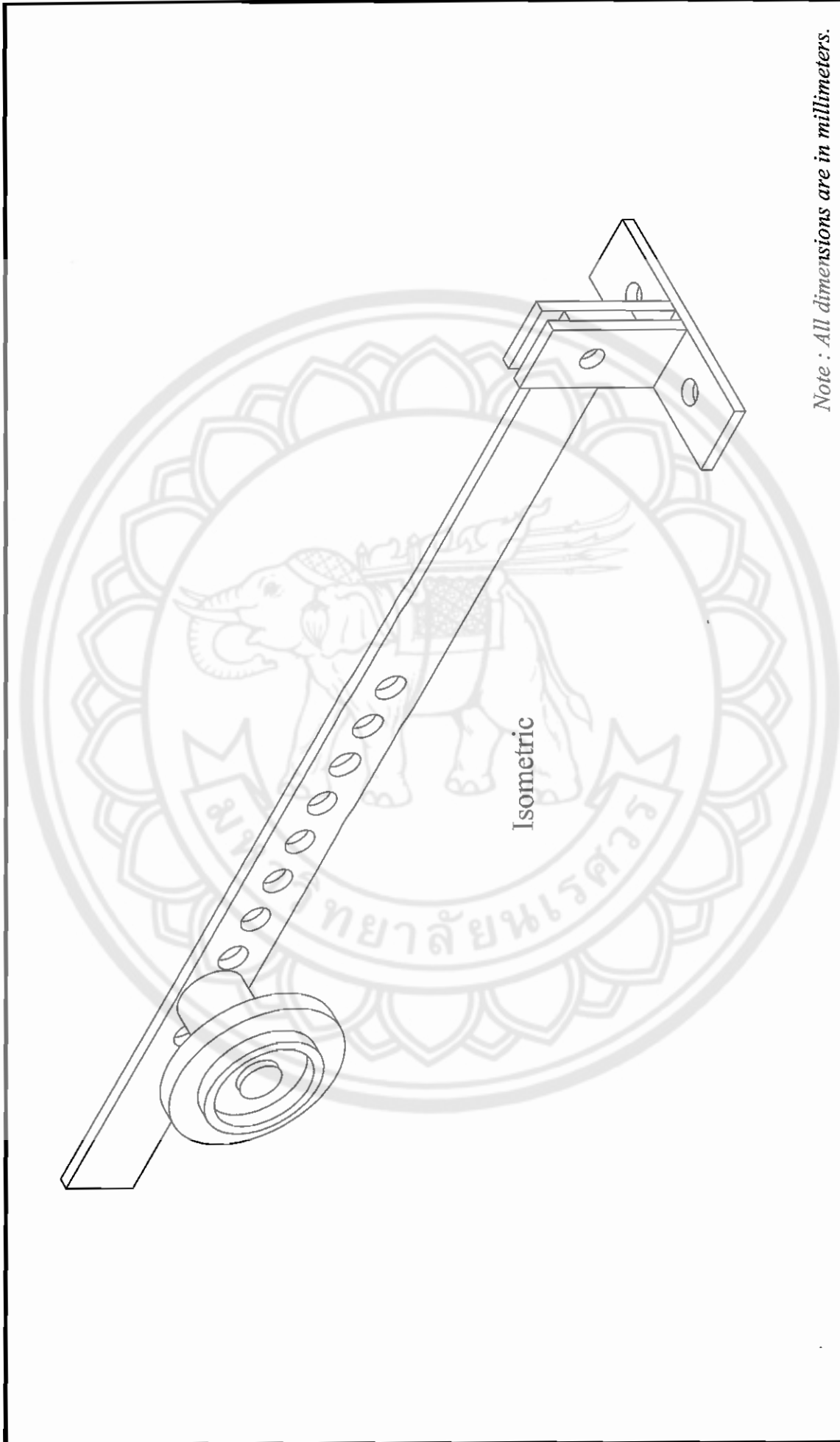

Note : All dimensions are in millimeters.

FACULTY OF ENGINEERING NARESUAN UNIVERSITY	ชุดตั้งโซ่		PROJECT	PLATE 32/32	SCALE 1:2.5
			DATE 09/10/06	DN BY :	NOPPORN SINTONG PANU THONGBOO PANUPAN BOONYON